

# SONY®

4-733-013-11(1)



## Television

Reference Guide

GB

參考指南

CT



## BRAVIA

KD-65X9000F / 55X9000F / 49X9000F

# Table of Contents

Safety Information . . . . .	2
Precautions . . . . .	5
Parts and Controls . . . . .	6
Controls and Indicators . . . . .	6
Using Remote Control . . . . .	7
Remote Control Parts Description . . . . .	7
Connection Diagram . . . . .	9
Installing the TV to the Wall . . . . .	11
Using the optional Wall-Mount Bracket . . . . .	11
SU-WL450 . . . . .	12
Troubleshooting . . . . .	15
Troubles and Solutions . . . . .	15
Specifications . . . . .	16

## Introduction

Thank you for choosing this Sony product. Before operating the TV, please read this manual thoroughly and retain it for future reference.

### Note

- Before operating the TV, please read the "Safety Information" (page 2).
- Instructions about "Installing the TV to the Wall" are included within this TV's instruction manual.
- Images and illustrations used in the Setup Guide and this manual are for reference only and may differ from the actual product.

## Attaching the Table-Top Stand to the TV

Refer to the Setup Guide on top of the cushion.

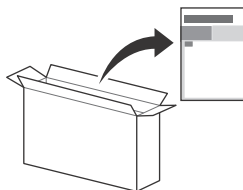

### Help

Find more troubleshooting and other useful information directly from your TV. Press **HELP** on the remote control to display a list of topics, or to search by keyword.

### Help Guide (Manual)

For more detailed information, select [Help Guide] from the Help menu on your TV. You can also check the Help Guide from your PC or smartphone (information provided on the back cover).

## Location of the identification label

Labels for the TV Model No. and Power Supply rating are located on the rear of the TV.

This television is designed for use in Hong Kong and ensured the usage in Hong Kong only.

## Safety Information

### WARNING

#### Caution

Risk of explosion if the battery is replaced by an incorrect type. Batteries must not be exposed to excessive heat such as sunshine, fire or the like or extremely low air pressure that can result in an explosion or leakage of flammable liquid or gas.

#### Stability Hazard

The television set may fall, causing serious personal injury or death.

Never place a television set in an unstable location. A television set may fall, causing serious personal injury or death. Many injuries, particularly to children, can be avoided by taking simple precautions such as:

- Using cabinets or stands recommended by the manufacturer of the television set.
- Only using furniture that can safely support the television set.
- Ensuring the television set is not overhanging the edge of the supporting furniture.
- Not placing the television set on tall furniture (for example, cupboards or bookcases) without anchoring both the furniture and the television set to a suitable support.
- Not placing the television set on cloth or other materials that may be located between the television set and supporting furniture.

- Educating children about the dangers of climbing on furniture to reach the television set or its controls. If your existing television set is being retained and relocated, the same considerations as above should be applied.

## Installation/Set-up

Install and use the TV set in accordance with the instructions below in order to avoid any risk of fire, electric shock or damage and/or injuries.

Apparatus connected to the protective earthing of the building installation through the mains connection or through other apparatus with a connection to protective earthing – and to a television distribution system using coaxial cable, may in some circumstances create a fire hazard. Connection to a television distribution system therefore has to be provided through a device providing electrical isolation below a certain frequency range (galvanic isolator, see EN 60728-11).

### Installation

- The TV set should be installed near an easily accessible AC power outlet (mains socket).
- Place the TV on a stable, level surface to prevent it from falling over and causing personal injury or property damage.
- Install the TV where it cannot be pulled, pushed, or knocked over.
- Install the TV so that the TV's Table-Top Stand does not protrude out from the TV stand (not supplied). If the Table-Top Stand protrudes out from the TV stand, it may cause TV set to topple over, fall down, and cause personal injury or damage to the TV.

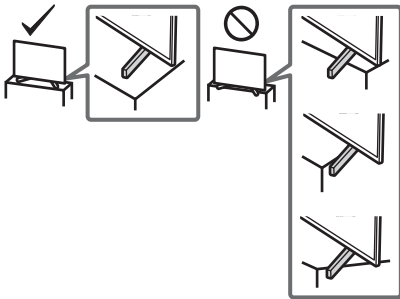

- Only qualified service personnel should carry out wall-mount installations.
- For safety reasons, it is strongly recommended that you use Sony accessories, including:
  - Wall-Mount Bracket SU-WL450
- Be sure to use the screws supplied with the Wall-Mount Bracket when attaching the Wall-Mount Bracket to the TV set. The supplied screws are designed as indicated by illustration when measured from the attaching surface of the Wall-Mount Bracket. The diameter and length of the screws differ depending on the Wall-Mount Bracket model. Use of screws other than those supplied may result in internal damage to the TV set or cause it to fall, etc.

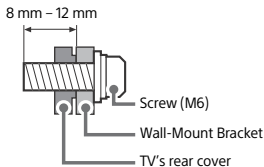

## Transporting

- Before transporting the TV set, disconnect all cables.
- Two or three people are needed to transport a large TV set.
- When transporting the TV set by hand, hold it as shown below. Do not put stress on the LCD panel and the frame around the screen.

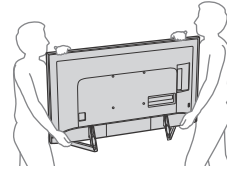

- When transporting the TV set, do not subject it to jolts or excessive vibration.
- When transporting the TV set for repairs or when moving, pack it using the original carton and packing material.

## Topple prevention

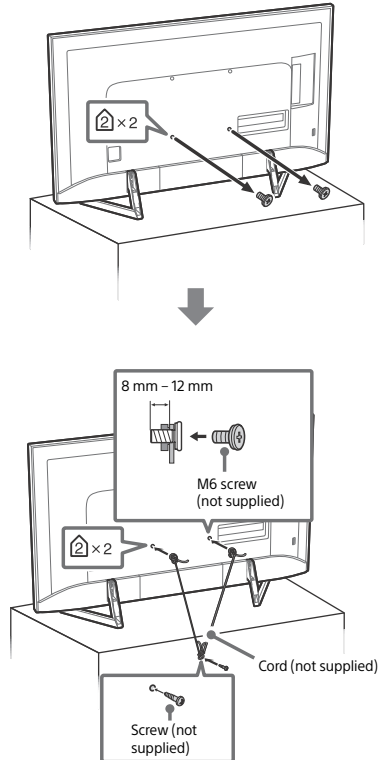

## Ventilation

- Never cover the ventilation holes or insert anything in the cabinet.
- Leave space around the TV set as shown below.
- It is strongly recommended that you use a Sony Wall-Mount Bracket in order to provide adequate air circulation.

### Installed on the wall

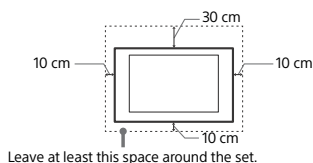

### Installed with stand

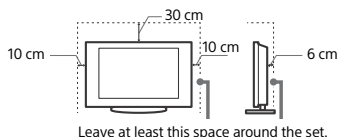

- To ensure proper ventilation and prevent the collection of dirt or dust:
  - Do not lay the TV set flat, install upside down, backwards, or sideways.
  - Do not place the TV set on a shelf, rug, bed or in a closet.
  - Do not cover the TV set with a cloth, such as curtains, or items such as newspapers, etc.
  - Do not install the TV set as shown below.

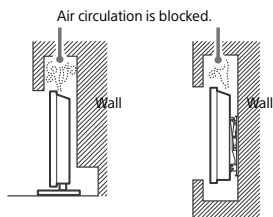

## AC power cord (mains lead)

Handle the AC power cord (mains lead) and outlet (mains socket) as follows in order to avoid any risk of fire, electric shock or damage and/or injuries:

- The shape of AC power plug (mains plug), which is supplied with the TV set, varies depending on the region. Be sure to connect the appropriate supplied AC power cord (mains lead) with the plug that fits into the AC power outlet (mains socket).
- Use only Sony supplied AC power cords (mains lead), not those of other brands.
- Insert the plug fully into the AC power outlet (mains socket).
- Operate the TV set on a 220 V - 240 V AC supply only.
- When wiring cables, be sure to unplug the AC power cord (mains lead) for your safety and take care not to catch your feet on the cables.
- Disconnect the AC power cord (mains lead) from the AC power outlet (mains socket) before working on or moving the TV set.
- Keep the AC power cord (mains lead) away from heat sources.
- Unplug the AC power plug (mains plug) and clean it regularly. If the plug is covered with dust and it picks up moisture, its insulation may deteriorate, which could result in a fire.

## Note

- Do not use the supplied AC power cord (mains lead) on any other equipment.
- Do not pinch, bend, or twist the AC power cord (mains lead) excessively. The core conductors may be exposed or broken.
- Do not modify the AC power cord (mains lead).
- Do not put anything heavy on the AC power cord (mains lead).
- Do not pull on the AC power cord (mains lead) itself when disconnecting the AC power cord (mains lead).
- Do not connect too many appliances to the same AC power outlet (mains socket).
- Do not use a poor fitting AC power outlet (mains socket).

## Prohibited Usage

Do not install/use the TV set in locations, environments or situations such as those listed below, or the TV set may malfunction and cause a fire, electric shock, damage and/or injuries.

### Locations:

- Outdoors (in direct sunlight), at the seashore, on a ship or other vessel, inside a vehicle, in medical institutions, unstable locations, near water, rain, moisture or smoke.

### Environments:

- Places that are hot, humid, or excessively dusty; where insects may enter; where it might be exposed to mechanical vibration, near flammable objects (candles, etc.). The TV set shall not be exposed to dripping or splashing and no objects filled with liquids, such as vases, shall be placed on the TV.

### Situations:

- Use when your hands are wet, with the cabinet removed, or with attachments not recommended by the manufacturer. Disconnect the TV set from AC power outlet (mains socket) and antenna (aerial) during lightning storms.
- Install the TV so that it sticks out into an open space. Injury or damage from a person or object bumping into the TV may result.



- Place the TV in a humid or dusty space, or in a room with oily smoke or steam (near cooking tables or humidifiers). Fire, electric shock, or warping may result.
- Install the TV in places subject to extreme temperature such as in direct sunlight, near a radiator or a heating vent. The TV may overheat in such condition which can cause deformation of the enclosure and/or TV malfunction.

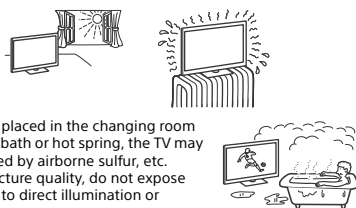

- If the TV is placed in the changing room of a public bath or hot spring, the TV may be damaged by airborne sulfur, etc.
- For best picture quality, do not expose the screen to direct illumination or sunlight.
- Avoid moving the TV from a cold area to a warm area. Sudden room temperature changes may cause moisture condensation. This may cause the TV to show poor picture and/or poor colour. Should this occur, allow moisture to evaporate completely before powering the TV on.

### Broken pieces:

- Do not throw anything at the TV set. The screen glass may break by the impact and cause serious injury.
- If the surface of the TV set cracks, do not touch it until you have unplugged the AC power cord (mains lead). Otherwise this may cause an electric shock.

## When not in use

- If you will not be using the TV set for several days, the TV set should be disconnected from the AC power (mains) for environmental and safety reasons.
- As the TV set is not disconnected from the AC power (mains) when the TV set is just turned off, pull the plug from the AC power outlet (mains socket) to disconnect the TV set completely.
- Some TV sets may have features that require the TV set to be left in standby to work correctly.

## For children

- Do not allow children to climb on the TV set.
- Keep small accessories out of the reach of children, so that they are not mistakenly swallowed.

## If the following problems occur...

**Turn off** the TV set and unplug the AC power cord (mains lead) immediately if any of the following problems occur. Ask your dealer or Sony service centre to have it checked by qualified service personnel.

### When:

- AC power cord (mains lead) is damaged.
- Poor fitting of AC power outlet (mains socket).
- TV set is damaged by being dropped, hit or having something thrown at it.
- Any liquid or solid object falls through openings in the cabinet.

## About LCD TV Temperature

When the LCD TV is used for an extended period, the panel surrounds become warm. You may feel hot when touching there by the hand.

## Precautions

### Viewing the TV

- View the TV in moderate light, as viewing the TV in poor light or during long period of time, strains your eyes.
- When using headphones, adjust the volume so as to avoid excessive levels, as hearing damage may result.

### LCD Screen

- Although the LCD screen is made with high-precision technology and 99.99 % or more of the pixels are effective, black dots may appear or bright points of light (red, blue, or green) may appear constantly on the LCD screen. This is a structural property of the LCD screen and is not a malfunction.
- Do not push or scratch the front filter, or place objects on top of this TV set. The image may be uneven or the LCD screen may be damaged.
- If this TV set is used in a cold place, a smear may occur in the picture or the picture may become dark. This does not indicate a failure. These phenomena disappear as the temperature rises.
- Ghosting may occur when still pictures are displayed continuously. It may disappear after a few moments.
- The screen and cabinet get warm when this TV set is in use. This is not a malfunction.
- The LCD screen contains a small amount of liquid crystal. Follow your local ordinances and regulations for disposal.

## Handling and cleaning the screen surface/cabinet of the TV set

Be sure to unplug the AC power cord (mains lead) connected to the TV set from AC power outlet (mains socket) before cleaning. To avoid material degradation or screen coating degradation, observe the following precautions.

- To remove dust from the screen surface/cabinet, wipe gently with a soft cloth. If dust is persistent, wipe with a soft cloth slightly moistened with a diluted mild detergent solution.
- Never spray water or detergent directly on the TV set. It may drip to the bottom of the screen or exterior parts and enter the TV set, and may cause damage to the TV set.
- Never use any type of abrasive pad, alkaline/acid cleaner, scouring powder, or volatile solvent, such as alcohol, benzene, thinner or insecticide. Using such materials or maintaining prolonged contact with rubber or vinyl materials may result in damage to the screen surface and cabinet material.
- Do not touch the TV if your hand is covered in any chemical substance such as hand cream or sunblock.
- Periodic vacuuming of the ventilation openings is recommended to ensure proper ventilation.
- When adjusting the angle of the TV set, move it slowly so as to prevent the TV set from moving or slipping off from its table stand.



GB

## Optional Equipment

- Keep optional components or any equipment emitting electromagnetic radiation away from the TV set. Otherwise picture distortion and/or noisy sound may occur.

## Wireless Function of the unit

- Do not operate this unit near medical equipment (pacemaker, etc.), as this may result in the malfunction of the medical equipment.
- Although this unit transmits/receives scrambled signals, be careful of unauthorised interception. We cannot be responsible for any trouble as a result.

## Caution about handling the remote control

- Observe the correct polarity when inserting batteries.
- Do not use different types of batteries together or mix old and new batteries.
- Dispose of batteries in an environmentally friendly way. Certain regions may regulate the disposal of batteries. Please consult your local authority.
- Handle the remote control with care. Do not drop or step on it, or spill liquid of any kind onto it.
- Do not place the remote control in a location near a heat source, a place subject to direct sunlight, or a damp room.

# Parts and Controls

## Controls and Indicators

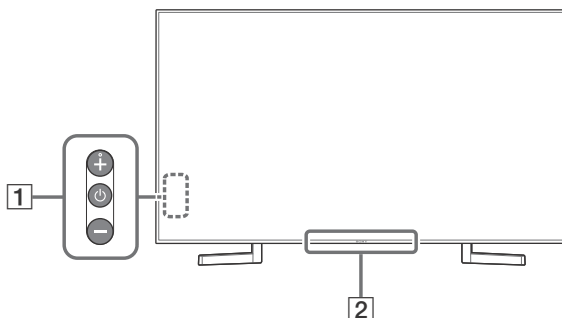



### 1 (Power) /+/-

**When the TV is off,**

Press  to power on.

**When the TV is on,**

Press and hold  to power off.

Press  repeatedly to change the function, then press + or - button to:

- Adjust the volume.
- Select the channel.
- Select the input source of TV.

### 2 Remote Control sensor\* / Light sensor\* / Illumination LED

The illumination LED lights up or blinks according to the status of the TV.

For more information, refer to the Help Guide.

\* Do not place anything near the sensor.

# Using Remote Control

## Remote Control Parts Description

The remote control shape, location, availability and function of remote control buttons may vary depending on your region/country/TV model.

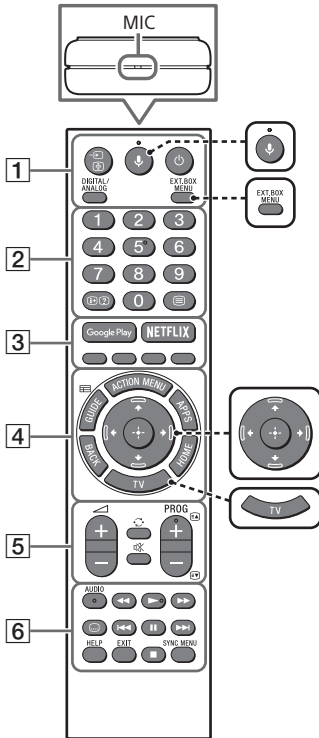

 **↓ (Microphone)**  
Use Voice Search. (e.g., Search various content by voice.)

 **EXT.BOX MENU**  
Display the External Box (cable/satellite box) menu only if HDMI CEC compatible device is connected.

 **↑/↓/←/→/⊕ (Navigation D-Pad)**  
On screen menu navigation and selection.



 **TV**  
Switch to a TV channel or input and display the TV Menu Bar.

GB

- 1**  **(Input select/Text hold)**  
In TV mode: Display and select the input source.  
In Text mode: Hold the current page.

 **(TV standby)**  
Turn on or turn off the TV (standby mode).

**DIGITAL/ANALOG**  
Switch between digital and analogue mode.

- 2** **Number buttons**
-   **(Info/Text reveal)**  
Display information.

 **(Text)**  
Display text information.

- 3** **Google Play**  
Access the "Google Play" online service.

**NETFLIX (Only on limited region/country/TV model)**  
Access the "NETFLIX" online service.

## Colour buttons

Execute corresponding function at that time.

## SYNC MENU

Display the BRAVIA Sync Menu.

### 4 ACTION MENU

Display a list of contextual functions.

#### GUIDE/

Display the digital programme guide.

#### APPS

Access various services and applications.

#### BACK

Return to the previous screen.

#### HOME

Display the TV Home Menu.

### 5 +/- (Volume)

Adjust the volume.

#### (Jump)



Jump back and forth between two channels or inputs. The TV alternates between the current channel or input and the last channel or input that was selected.

#### (Muting)

Mute the sound. Press again to restore the sound.

#### PROG +/-//

In TV mode: Select the channel.

In Text mode: Select the next () or previous () page.

### 6 AUDIO

Change the language for the programme currently being viewed.

#### 

Operate media contents on the TV and connected BRAVIA Sync-compatible device.

#### (Subtitle setting)

Turn subtitles on or off (when the feature is available).

#### HELP

Display the Help menu. Help Guide can be accessed from here.

#### EXIT

Return to the previous screen or exit from the menu. When an Interactive Application service is available, press to exit from the service.



# Connection Diagram

For more information on connections, refer to the Help Guide by pressing **HELP** on the remote control.

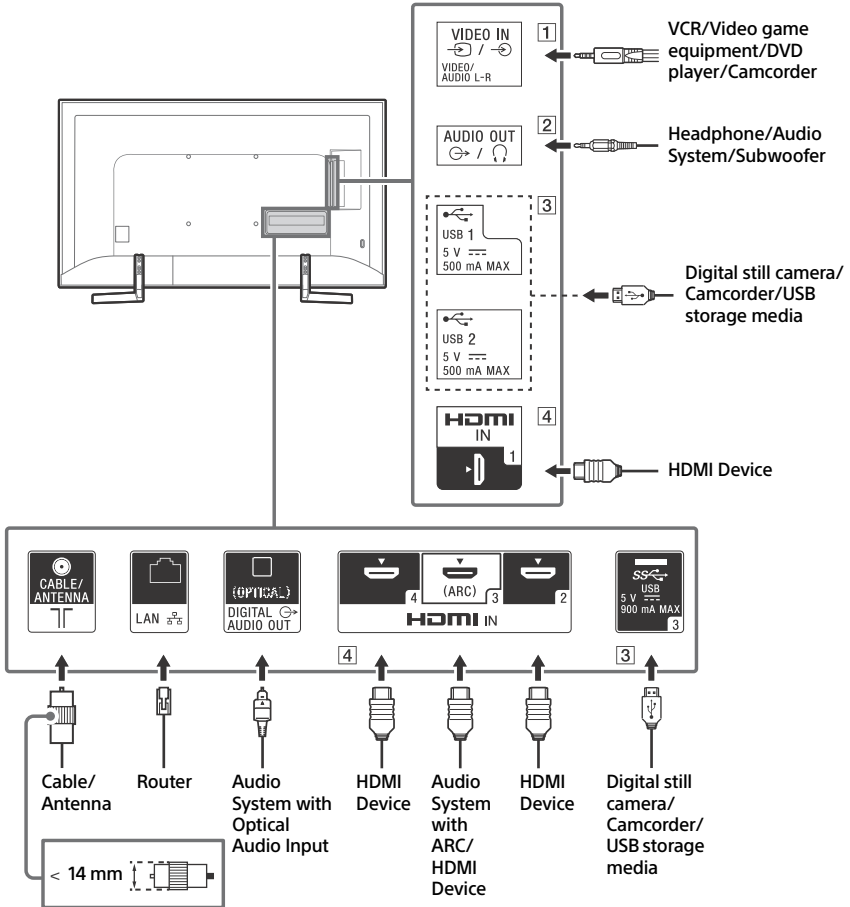

GB

## 1 VIDEO IN

- For a composite connection, use an Analogue Extension Cable (not supplied).

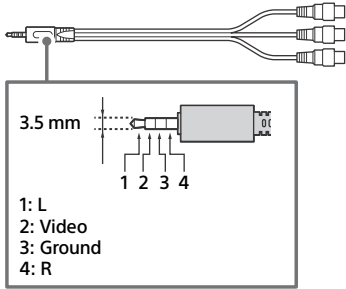

## 2 AUDIO OUT

- Supports 3-pole stereo mini jack only.
- To listen to the TV's sound through the connected equipment, press **HOME**. Select [Settings] → [Sound] → [Headphone/Audio out] and then select the desired item.

## 3 USB 1/2, USB 3

- Connecting a large USB device may interfere with other connected devices beside it.
- When connecting a large USB device, connect to the USB 1 port.

## 4 **HDMI IN 1/2/3/4**

- HDMI interface can transfer the digital video and audio on a single cable.

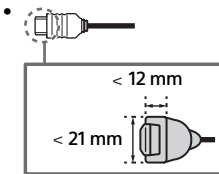

### • **HDMI IN 2/3**

To enjoy high quality 4K 50p/60p contents, connect a Premium High Speed HDMI cable to the HDMI IN 2/3 and set the [HDMI signal format] to [Enhanced format].

For details of supported formats, refer to the "Specifications" in this manual (page 16-17).

### • **HDMI IN 3 ARC (Audio Return Channel)**

Connect your audio system to the HDMI IN 3 to route TV audio to your audio system. An audio system that supports HDMI ARC can send video to the TV, and receive audio from the TV via the same HDMI cable. If your audio system does not support HDMI ARC, an additional connection with DIGITAL AUDIO OUT (OPTICAL) is necessary.

# Installing the TV to the Wall

## Using the optional Wall-Mount Bracket

This TV's instruction manual only provides the steps to prepare the TV for Wall-Mount installation before it is installed on the wall.

### To Customers:

For product protection and safety reasons, Sony strongly recommends that installation of your TV be performed by Sony dealers or licensed contractors. Do not attempt to install it yourself.

### To Sony Dealers and Contractors:

Provide full attention to safety during the installation, periodic maintenance and examination of this product.

GB

Sufficient expertise is required for installing this product, especially to determine the strength of the wall for withstanding the TV's weight. Be sure to entrust the attachment of this product to the wall to Sony dealers or licensed contractors and pay adequate attention to safety during the installation. Sony is not liable for any damage or injury caused by mishandling or improper installation.

Use the Wall-Mount Bracket SU-WL450 (not supplied) to install the TV to the wall.

When installing the Wall-Mount Bracket, also refer to the Operating Instructions and Installation Guide supplied with the Wall-Mount Bracket.

### Note

- Be sure to store the removed screws in a safe place, keeping them away from children.

### Remove the screws from the rear of the TV.

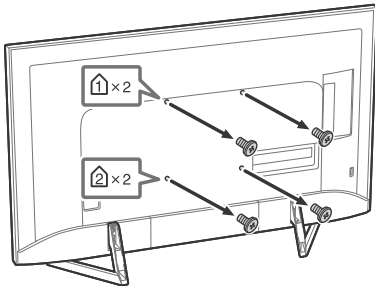

# SU-WL450

- 1 Make sure that the wall has enough space for the TV and is capable of supporting a weight of at least four times that of the TV. Refer to the following table on installing the TV to the wall. See page 16-17 (Specifications) for the TV's weight.

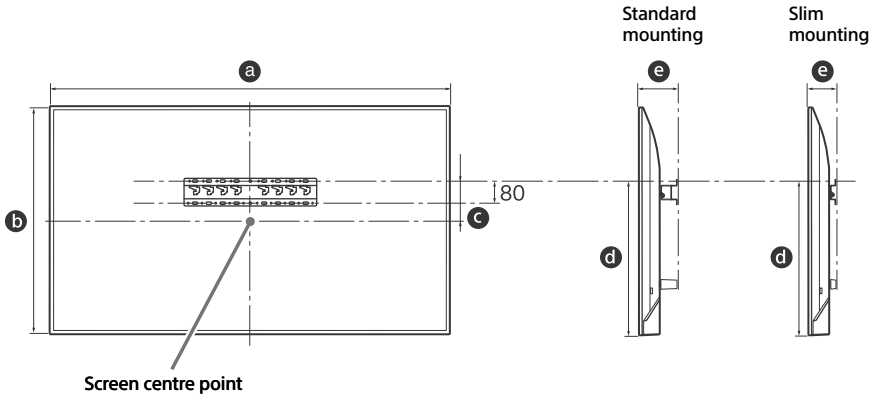

Unit: mm

Model Name	Display dimensions		Screen centre dimension	Length for mounting		
	a	b	c	d	Standard mounting	Slim mounting
KD-65X9000F	1,447	829	211	628	132	90
KD-55X9000F	1,228	706	187	543	132	90
KD-49X9000F	1,093	629	163	480	132	90

**Note**

- Figures in the table may differ slightly depending on the installation.
- When your TV is installed on the wall, the upper side of the TV slightly leans forward.

- 2 Attach the Attachment parts for Wall-Mount Bracket. Check the Attachment parts by referring to "1" of the Wall-Mount Bracket Installation Guide.

**Note**

- If using an electric screwdriver, set the torque at approximately 1.5 N·m {15 kgf·cm}.
- Be sure to store the unused parts in a safe place for future use. Retain this manual for future reference.

## Standard mounting

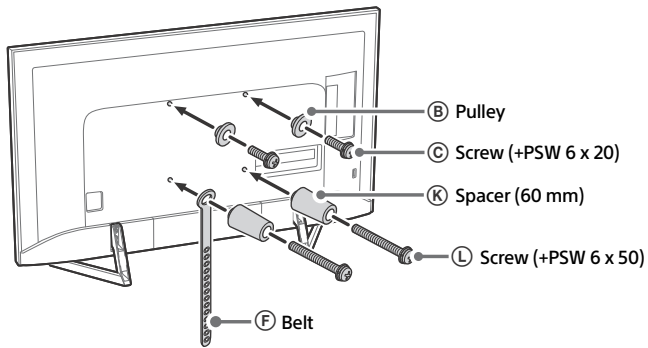

## Slim mounting

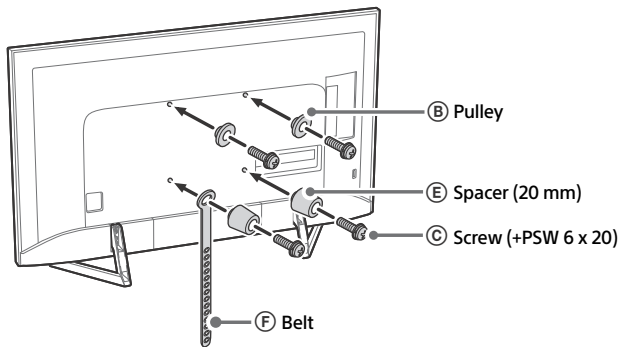

### 3 Connect necessary cables to the TV.

#### Note

- You cannot access to any terminal after installing the TV to the wall.

### 4 Detach the Table-Top Stand from the TV.

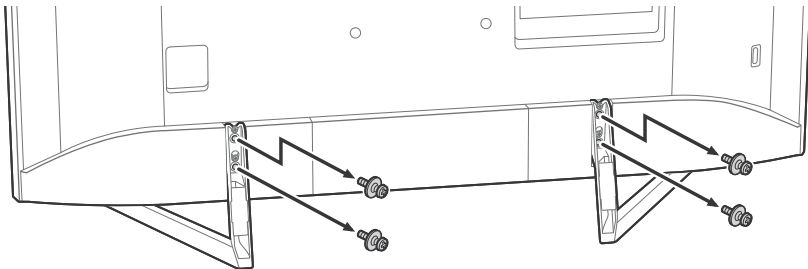

**5** Install the TV to the Base. Refer to “5” of Installation Guide and “Installing the TV to the Wall” of Operating Instructions supplied with the Wall-Mount Bracket.

Model Name	Hook location
KD-65X9000F	b
KD-55X9000F	b
KD-49X9000F	c

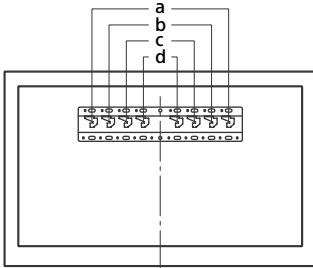

Refer to the instructions supplied with the Wall-Mount Bracket for your model to install the TV on the wall.

## Troubleshooting

General troubleshooting for issues like: black screen, no sound, frozen picture, TV does not respond, or network is lost, do the following steps.

- 1 Restart your TV by pressing the power button on the remote control until a message appears. The TV will restart. If the TV does not recover, try unplugging the TV from the AC power cord (mains lead) for two minutes and then plug it in again.
- 2 Refer to the Help menu by pressing **HELP** on the remote control.
- 3 Connect your TV to the Internet and perform a software update.
- 4 Visit Sony support website (information provided on the back cover).

### **When [A new TV system software update is available...] message is displayed.**

Sony strongly recommends you to update the TV software by selecting [Update Now]. These software updates improve your TV performance or add new features.

The following screen with [Updating...] will appear and the illumination LED flashes white while software is updating.

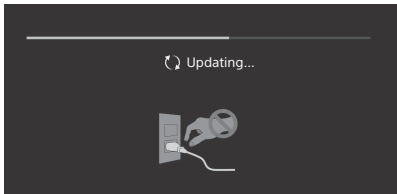

Do not unplug the AC power cord (mains lead) during the software update. If you do, the software update may not finish completely, and it may cause a software malfunction. Software updates can take up to 15 minutes.

### **When you plug in the TV, the TV may not be able to turn on for a while even if you press the power button on the remote control or the TV.**

It takes time to initialize the system. Wait for about one minute, then operate it again.

## Troubles and Solutions

### **When the illumination LED is flashing in red.**

- Count how many times it flashes (interval time is three seconds).

Reboot the TV by disconnecting the AC power cord (mains lead) for two minutes, then turn on the TV.

If the problem persists, disconnect the AC power cord (mains lead), and contact your dealer or Sony service centre with the number of times the illumination LED flashes.

### **There is no picture (screen is dark) and no sound.**

- Check the antenna (aerial)/cable connection.
- Connect the TV to the AC power (mains), and press the power button on the TV or the remote control.

### **Some programmes cannot be tuned.**

- Check the antenna (aerial)/cable connection.

### **The remote control does not function.**

- Replace the batteries.

### **The EXT.BOX MENU button on the remote control does not work.**

- Connect HDMI CEC compatible device and change to that input.

### **The parental lock for broadcast password has been forgotten.**

- Enter 9999 for the PIN code and select [Change PIN Code].

### **The TV surrounds become warm.**

- When the TV is used for an extended period, the TV surrounds become warm. You may feel hot when touching there by the hand.

# Specifications

## System

### Panel system

LCD (Liquid Crystal Display) Panel, LED Backlight

### TV system

Analogue: I, D/K, B/G, M

Digital: DTMB

### Colour system

PAL/SECAM/NTSC3.58/NTSC4.43

### Channel coverage

Analogue: UHF/VHF/Cable

Digital: UHF

### Sound output

10 W + 10 W

### Wireless technology

Protocol IEEE802.11ac/a/b/g/n

Bluetooth Version 4.1

## Input/Output jacks

### Antenna (aerial)/cable

75 ohm external terminal for VHF/UHF

### VIDEO IN

Video/Audio input (mini jack)

### HDMI IN 1/2/3/4 (support 4K resolution, HDCP 2.2-compatible)

#### Video:

4096 × 2160p (50, 60 Hz)<sup>\*1\*2</sup>, 4096 × 2160p (24 Hz)<sup>\*1</sup>, 3840 × 2160p (50, 60 Hz)<sup>\*2</sup>, 3840 × 2160p (24, 25, 30 Hz), 1080p (30, 50, 60 Hz), 1080/24p, 1080i (50, 60 Hz), 720p (30, 50, 60 Hz), 720/24p, 576p, 576i, 480p, 480i, PC Formats<sup>\*3</sup>

\*1 When 4096 × 2160p is input and [Wide mode] is set to [Normal], the resolution is displayed as 3840 × 2160p. To display 4096 × 2160p, set [Wide mode] setting to [Full 1] or [Full 2].

\*2 HDMI IN 2/3 only. To support 18 Gbps, set [HDMI signal format] to [Enhanced format].

\*3 Refer to the Help Guide for details.

#### Audio:

5.1 channel linear PCM: 32/44.1/48/88.2/96/176.4/192 kHz 16/20/24 bits, Dolby Digital, Dolby Digital Plus and DTS

### ARC (Audio Return Channel) (HDMI IN 3 only)

(Two channel linear PCM: 48 kHz 16 bits, Dolby Digital, Dolby Digital Plus, DTS)

### DIGITAL AUDIO OUT (OPTICAL)

Digital optical jack (Two channel linear PCM: 48 kHz 16 bits, Dolby Digital, DTS)

### AUDIO OUT (Stereo mini jack)

Headphone, Audio output, Subwoofer

### USB 1, 2, SS 3

USB port 1 and 2 support High Speed USB (USB 2.0)

USB port 3 supports Super Speed USB (USB 3.1 Gen 1)

### LAN

10BASE-T/100BASE-TX connector (Depending on the operating environment of the network, connection speed may differ. 10BASE-T/100BASE-TX communication rate and communication quality are not guaranteed for this TV.)

## Others

### Optional accessories

Wall-Mount Bracket: SU-WL450

### Operating temperature

0 °C – 40 °C

### Operating humidity

10 % – 80 % RH (non-condensing)

## Power and others

### Power requirements

220 V – 240 V AC, 50 Hz

### Screen size (measured diagonally) (Approx.)

KD-65X9000F: 65 inches / 163.9 cm

KD-55X9000F: 55 inches / 138.8 cm

KD-49X9000F: 49 inches / 123.2 cm

### Power consumption

Indicated on the rear of the TV

### Standby power consumption<sup>\*1\*2</sup>

0.5 W

### Display resolution

3,840 pixels (horizontal) × 2,160 lines (vertical)

### Output Rating

USB 1/2

5 V ⚡, 500 mA MAX

USB 3

5 V ⚡, 900 mA MAX

## Dimensions (Approx.) (w × h × d)

### with Table-Top Stand

KD-65X9000F: 1,447 × 898 × 297 mm

KD-55X9000F: 1,228 × 771 × 268 mm

KD-49X9000F: 1,093 × 694 × 268 mm

### without Table-Top Stand

KD-65X9000F: 1,447 × 829 × 69 mm

KD-55X9000F: 1,228 × 706 × 69 mm

KD-49X9000F: 1,093 × 629 × 69 mm



## Mass (Approx.)

with Table-Top Stand

KD-65X9000F: 25.5 kg

KD-55X9000F: 19.1 kg

KD-49X9000F: 14.5 kg

without Table-Top Stand

KD-65X9000F: 24.5 kg

KD-55X9000F: 18.2 kg

KD-49X9000F: 13.6 kg

\*1 Specified standby power is reached after the TV finishes necessary internal processes.

\*2 Standby power consumption will increase when your TV is connected to the network.

### Note

- Optional accessories availability depends on countries/region/TV model/stock.
- Design and specifications are subject to change without notice.

## Trademark information

- The terms HDMI and HDMI High-Definition Multimedia Interface, and the HDMI Logo are trademarks or registered trademarks of HDMI Licensing Administrator, Inc. in the United States and other countries.
- Manufactured under license from Dolby Laboratories. Dolby, Dolby Audio, and the double-D symbol are trademarks of Dolby Laboratories.
- "BRAVIA", BRAVIA and BRAVIA Sync are trademarks or registered marks of Sony Corporation.
- Gracenote, the Gracenote logo and logotype, "Powered by Gracenote" logo are either registered trademarks or trademarks of Gracenote, Inc. in the United States and/or other countries.
- Vewd® Core. Copyright 1995-2017 Vewd Software AS. All rights reserved.
- Google, Android TV, Google Play, Chromecast built-in, YouTube and other related marks and logos are trademarks of Google LLC.
- Wi-Fi®, Wi-Fi Alliance®, Wi-Fi Direct® and Miracast® are registered trademarks of Wi-Fi Alliance.
- Wi-Fi Protected Setup™ is a trademark of Wi-Fi Alliance.
- The Wi-Fi CERTIFIED™ Logo is a certification mark of Wi-Fi Alliance.

- For DTS patents, see <http://patents.dts.com>. Manufactured under license from DTS, Inc. DTS, the Symbol, & DTS and the Symbol together are registered trademarks, and DTS Digital Surround is a trademark of DTS, Inc. © DTS, Inc. All Rights Reserved.
- The Bluetooth® word mark and logos are registered trademarks owned by the Bluetooth SIG, Inc. and any use of such marks by Sony Corporation is under license. Other trademarks and trade names are those of their respective owners.
- Netflix is a registered trademark of Netflix, Inc.
- © 2017 RealNetworks, Inc. All rights reserved. Patents pending. RealMedia, RealNetworks, and their logos are trademarks or registered trademarks of RealNetworks, Inc.
- TUXERA is a registered trademark of Tuxera Inc. in the US and other countries.
- USB-IF SuperSpeed USB Trident logo is a registered trademark of USB Implementers Forum, Inc. 
- All other trademarks are the property of their respective owners.

GB

**HDMI**™  
HIGH-DEFINITION MULTIMEDIA INTERFACE





**4K**

Actual resolution:  
3840 x 2160 pixels



# 目錄

安全資訊 . . . . .	2
預先注意事項 . . . . .	4
組件及控件 . . . . .	6
控件及指示燈 . . . . .	6
使用遙控器 . . . . .	7
遙控器組件說明 . . . . .	7
連接圖 . . . . .	9
將電視機安裝在牆上 . . . . .	11
使用選購的壁掛式支架 . . . . .	11
SU-WL450 . . . . .	12
故障排除 . . . . .	15
故障及解決方案 . . . . .	15
規格 . . . . .	16

## 簡介

感謝您購買這項 Sony 產品。  
使用電視機之前，請詳閱本手冊，並保留下來以便將來參考。

### 註

- 使用電視機之前，請詳讀“安全資訊”（第 2 頁）。
- 有關“將電視機安裝在牆上”的指示已包含在這台電視機的使用說明書。
- 安裝指南和本說明書中使用的影像和插圖僅作參考並可能與實際產品不同。

## 將桌面底座安裝至電視機

請參閱軟墊上的安裝指南。

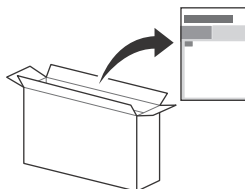

### 說明

直接從電視機獲取更多故障排除資訊和其他有用資訊。按遙控器上的 **HELP** 以顯示主題清單，或透過關鍵字搜尋。

### 說明指南（說明書）

有關更多資訊，請從電視機上的說明選單選擇 [說明指南]。您也可以從您的 PC 或智能手機查看說明指南（封底提供的資訊）。

## 識別標籤的位置

電視機型號和電源等級的標籤位於電視機背面。

本電視設計在香港使用，只保證能在香港使用。

## 安全資訊

### 警告

#### 注意事項

若以不正確類型的電池進行更換，可能會有爆炸的危險。  
不可將電池曝露於如陽光、火或類似的過熱源或者極低的氣壓，以避免引起爆炸或可燃性液體或氣體洩漏。

#### 穩固危險

電視機可能翻倒，造成嚴重人身傷害或死亡。  
切勿將電視安置在不穩定的地方。電視可能跌落、造成嚴重人身傷害或導致死亡。為避免尤其是對孩童造成傷害，可採取簡單的預先注意事項，如：

- 使用電視製造商推薦的機櫃或支架。
  - 僅使用可安全支撐電視的傢俱。
  - 確保電視不會置於支撐傢俱的邊緣處。
  - 未將傢俱與電視固定在合適的支架上時，勿將電視置於較高的傢俱（如櫥櫃或書櫃）之上。
  - 切勿在電視與支撐傢俱之間擺放布料或其他材料。
  - 教育孩童攀爬傢俱去觸摸電視或其控制器是相當危險的。
- 如果您現有的電視仍在使用且已重新安放，則同樣適用上述注意事項。

## 安裝 / 設定

為了避免火災、觸電或損壞及 / 或受傷等危險，請遵照下列指示來安裝和使用電視機。

若裝置透過電源接線或透過帶有保護地線連接設備的其他裝置與建築安裝的保護接地連接，以及使用同軸電纜與電視分配系統連接，則在某些情況下可能導致火災危險。因此，必須透過在特定頻率範圍內提供電氣隔離的設備（電流隔離器，參閱 EN 60728-11）提供與電視分配系統的連接。

## 安裝

- 應將電視機安裝在易於插拔的 AC 電源插座附近。
- 將電視機放在一個穩定的平面，以防止墜落和引起個人傷害或財產損壞。
- 應將電視機安裝在不容易被拉、推或碰倒之處。
- 安裝電視機，使電視機的桌面底座不會從電視機櫃（非附帶）凸出。如果桌面底座從電視機櫃凸出，可能導致電視機翻倒、掉落及人身傷害或對電視機造成損壞。

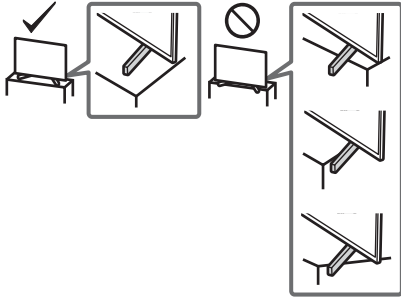

- 僅可由合格的維修人員執行掛壁安裝。
- 為了安全起見，強烈建議您使用 Sony 配件，包括：
  - 壁掛式支架 SU-WL450
- 將掛鉤（底座）/ 壁掛式支架安裝於電視機上時，務必使用隨附於壁掛式支架的螺絲。隨附螺絲如插圖所示設計從掛鉤（底座）/ 壁掛式支架安裝表面量起。螺絲的直徑和長度會因為壁掛式支架的型號而有所不同。使用隨附螺絲以外的螺絲可能會造成電視機內部損壞或者掉落等等。

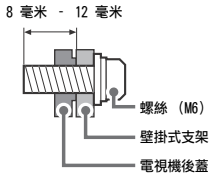

## 搬動

- 搬動電視機之前，請斷開所有纜線的連接。
- 大尺寸電視機需要兩到三人搬動。
- 用手搬動電視機時，請如下圖所示抓握。請勿對液晶面板以及螢幕周圍的框邊施加壓力。

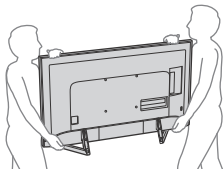

- 搬動電視機時，請勿使其受到搖晃或過度震動。
- 搬動電視機以進行維修或移動時，請使用原有的紙箱和包裝材料進行包裝。

## 防止傾倒

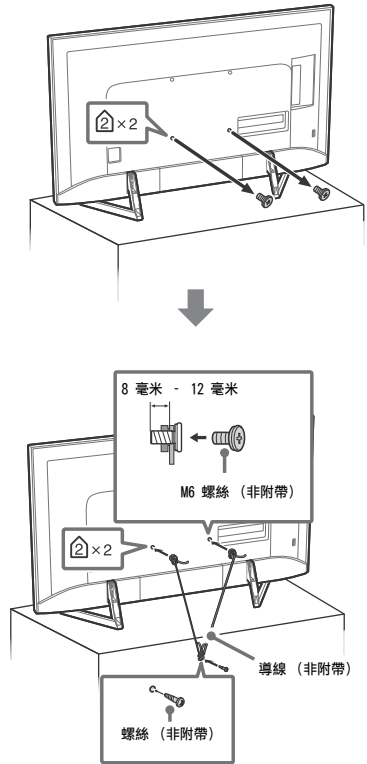

## 通風

- 切勿遮擋通風孔或將任何物體插入機殼內。
- 如下圖所示，在電視機周圍保留通風空間。
- 強烈建議您使用 Sony 壁掛式支架以確保足夠的空氣流通。

## 安裝在牆壁上

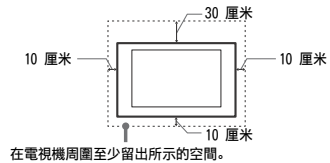

## 安裝在底座上

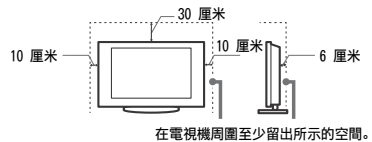

- 為了確保正確通風及防止髒物或灰塵堆積：
  - 請勿將電視機平放、上面朝下安裝、向後安裝或側面安裝。
  - 請勿將電視機放置於架子、地毯、床或壁櫥中。
  - 請勿用布（如窗簾）或物件（如報紙等）覆蓋電視機。
  - 請勿如下圖所示安裝電視機。

空氣流通被阻擋。

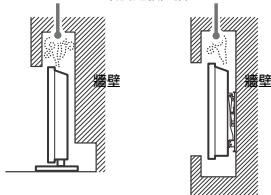

- 將電視機安裝在會遭受極端溫度的地方，如陽光直射、靠近散熱器或加熱裝置通風孔。電視機在這種環境下可能會過熱而導致外殼變形及 / 或電視機故障。

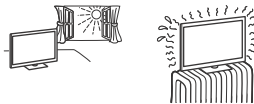

- 如果放置電視機在公共浴室或溫泉的更衣室內，電視機可能會被空氣中的硫磺等損壞。
- 若要獲得最佳的畫面品質，請勿將螢幕放在直射光源或陽光下。
- 避免將電視機從寒冷的區域移至溫暖的區域。突然的室溫變化可能導致濕氣凝結。這可能造成電視機顯示劣質圖像及 / 或暗淡的顏色。如果發生這種情形，讓濕氣完全蒸發之後才開啟電視機。



## AC 電源線

為了避免火災、觸電或損壞及 / 或受傷等危險，請遵照下列指示來處理 AC 電源線和插座：

- 電視機附帶的 AC 電源插頭的形狀視區域而不同。確保連接合適的附帶 AC 電源線，插頭要適合 AC 電源插座。
- 僅使用 Sony 隨附的 AC 電源線，不能使用其他品牌的電源線。
- 將插頭完全插入 AC 電源插座。
- 僅可在 220 V - 240 V AC 電源上使用電視機。
- 連接纜線時，為了安全起見請務必拔下 AC 電源線，以免被纜線絆到腳。
- 在進行作業或移動電視機之前，請從 AC 電源插座上斷開 AC 電源線的連接。
- 保持 AC 電源線遠離熱源。
- 拔下 AC 電源插頭，定期進行清潔。如果插頭上有灰塵積聚並帶有濕氣，則其絕緣品質可能已經劣化，並可能會造成火災。

## 註

- 請勿將隨附的 AC 電源線用於任何其他設備。
- 請勿過度彎折、彎曲或扭轉 AC 電源線。否則線芯可能會曝露在外或折斷。
- 請勿改裝 AC 電源線。
- 請勿將任何重物放在 AC 電源線上。
- 斷開 AC 電源線連接時，請勿拉扯 AC 電源線。
- 請勿在相同的 AC 電源插座上連接太多設備。
- 請勿使用不適當的 AC 電源插座。

## 使用限制

請勿在下列地點、環境或情況條件下安裝 / 使用電視機，否則電視機可能會發生故障並造成火災、觸電、損壞及 / 或受傷等危險。

### 地點：

- 室外（在直射的陽光中），海邊，船上或其他船艙上，車內，醫療機構中，不穩定的場所，靠近水、雨、濕氣或煙霧的地方。

### 環境：

- 炎熱潮濕或太多灰塵的地方；昆蟲可能進入的地方；可能受到機械式震動的地方；靠近易燃物體（蠟燭等）的地方。不應該讓液體滴濕或噴濕電視機，而且裝滿液體的物體（例如花瓶）不應該擺在電視機上。

### 情況條件：

- 機櫃被拆卸或使用非生產商推薦的附件時，雙手潮濕狀態下使用。出現雷電時請將電視機電源線從 AC 電源插座和天線拔下。
- 安裝電視機時使其突出至開放的空間。可能會導致人或物體撞擊電視機而引起傷害或損壞。



- 把電視機放置在潮濕或多塵的空間，或有油煙或蒸氣的房間內（靠近灶台或加濕器）。這可能導致火災、觸電或本機彎曲。

## 打破電視機螢幕：

- 請勿將任何物品丟向電視機。否則螢幕可能會因為受到撞擊而破裂並造成嚴重傷害。
- 如果電視機的表面破裂，在拔下 AC 電源線以前請勿觸摸它。否則會引起觸電。

## 不使用時

- 如果您不使用電視機數天，為了環保和安全原因，應將電視機電源線從 AC 電源插座上拔下。
- 關閉電視機電源時，電視機並未與 AC 電源斷開連接，請將插頭從 AC 電源插座上拔下以完全斷開電視機的電源連接。
- 某些電視機可能具有需要將電視機保持在待命模式下才能正常工作的特點。

## 對於兒童

- 請勿讓兒童爬上電視機。
- 將體積小的配件放在兒童拿不到的地方，以便不會被兒童誤吞。

## 如果出現下列問題...

如果出現以下任何問題，請立刻**關閉**電視機並拔下 AC 電源線。請諮詢您的經銷商或 Sony 服務中心以交由合格的服務人員進行檢查。

### 當：

- AC 電源線損壞。
- AC 電源插座不適當。
- 電視機由於跌落、敲擊或撞擊而損壞。
- 任何液體或固體物件通過開口處掉入機殼內。

## 關於液晶電視機溫度

長時間使用液晶電視機時，面板周圍溫度會升高。用手觸摸這些地方時可能會覺得很燙。

## 預先注意事項

### 觀賞電視

- 請在適當光線條件下觀賞電視，因為在光線不足條件下或長時間觀賞電視會損傷您的眼睛。
- 使用耳機時，請調整音量以免音過高損傷聽力。

### LCD 螢幕

- 雖然 LCD 螢幕採用最精密技術製造且 99.99 % 以上的像素有效，但還是可能會出現黑點或 LCD 螢幕上可能會經常出現亮點（紅、藍或綠色）。這是 LCD 螢幕的結構特性，並不是故障。
- 請勿按壓或刮傷前遮光面板或在電視機頂部放置物件。畫面可能會不均，或者 LCD 螢幕可能會損壞。
- 如果在寒冷地點使用本電視機，畫面上可能會出現模糊或變暗。這並不是故障。溫度上升後這些現象就會消失。
- 畫面靜止不動將會產生重影。片刻後該現象將消失。
- 電視機使用過程中，螢幕和機殼會變熱。這不是故障。
- LCD 螢幕含有少量液晶。請按照您當地的法規進行廢棄物處理。

## 使用和清潔電視機的螢幕表層 / 機殼

清潔前，務必將電視機的 AC 電源線從 AC 電源插座上斷開連接。為了避免物質或螢幕塗層剝離，請遵照下列預先注意事項。

- 若要擦去螢幕表層 / 機殼上的灰塵，請用軟布輕輕擦拭。如果灰塵較難除去，請用稍稍蘸有稀釋中性清潔溶劑的軟布進行擦拭。
- 絕對不能將水或清潔劑直接噴灑在電視上。液體可能滴落在螢幕的底部或外部零件上並滲入電視內，而毀壞電視。
- 切勿使用任何類型的磨砂墊、鹼性 / 酸性清潔劑、擦洗粉或揮發溶劑，如酒精、汽油、稀釋劑或殺蟲劑。使用上述材料或與橡膠或乙烯材料長時間接觸可能會造成螢幕表面和機殼材料的損壞。
- 如果手上塗有任何化學品，例如手霜或防曬霜，請勿觸摸電視機。
- 建議您定期吸塵以清理通風口以確保通風順暢。
- 當調整電視機的角度時，請慢慢地調動以防電視機從其桌面型底座移動或滑落。



## 選購設備

- 將產生電磁輻射的選購元件或任何其他設備遠離電視機。否則可能會造成畫面失真及 / 或噪聲。

## 本機的無線功能

- 請勿在醫療設備（心臟起搏器等）附近操作本機，因為會引起醫療設備故障。
- 雖然本機發送 / 接收加擾信號，請小心未經授權的截取。我們不對此造成的任何問題負責。

## 注意有關處理遙控器

- 安裝電池時請注意正確的極性位置。
- 請勿同時使用不同類型的電池或混合使用新舊電池。
- 請以符合環境保護規定的方式來丟棄電池。特定地區可能有制訂廢棄電池的相關規定。請向您當地的主管機關查詢。
- 請小心拿取遙控器。請勿讓遙控器掉落或踩在遙控器上，或是讓任何液體灑到遙控器。
- 請勿將遙控器放置在接近熱源的地方，放置在受日光直射地方或潮濕的房間。

# 組件及控件

## 控件及指示燈

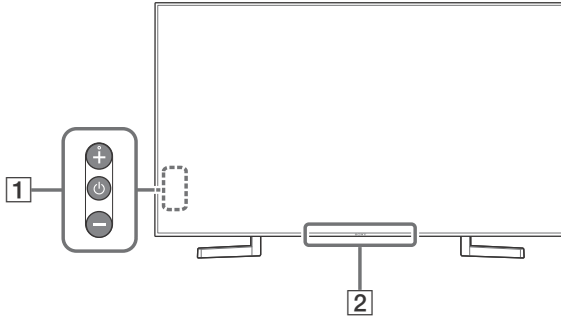

- 1** **⏻ (電源) /+/-**  
當電視機處於關機狀態時，  
請按 **⏻** 開機。  
打開電視機時，  
按住 **⏻** 關機。  
重複按 **⏻** 以變更功能，然後按 **+** 或 **-** 按鈕  
執行下列操作：
- 調節音量。
  - 選擇頻道。
  - 選擇電視機輸入源。
- 2** **遙控器感應器 \* / 光感應器 \* / 照明 LED**  
根據電視機的狀態，照明 LED 會亮起或閃爍。  
有關更多資訊，請參閱說明指南。

\* 請勿在感應器附近放置任何物品。



# 使用遙控器

## 遙控器組件說明

遙控器外形、按鈕的位置、可用性與功能視您的國家 / 區域 / 電視機型號而可能略有不同。

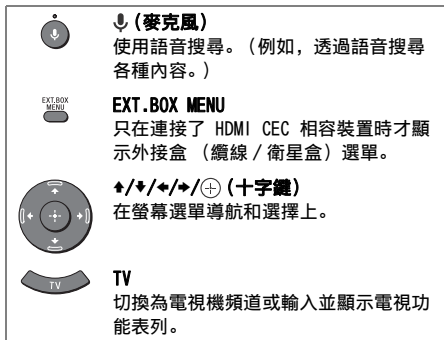
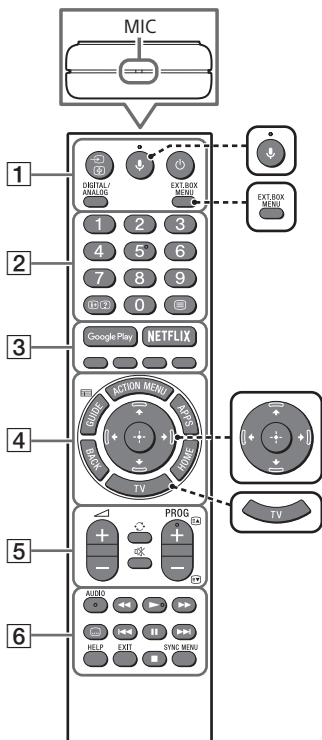

### 1 / (輸入選擇 / 文字保留)

電視模式：顯示並選擇輸入來源。  
文字模式：保留當前頁面。

### (電視待機)

開啟或關閉電視機 (待機模式)。

### DIGITAL/ANALOG

在數位及模擬模式之間切換。

### 2 數字按鈕

#### / (顯現資訊 / 文字)

顯示資訊。

### (文字)

顯示文字資訊。

### 3 Google Play

訪問“Google Play”線上服務。

### NETFLIX (僅限限制的區域 / 國家 / 電視機型號)

訪問“NETFLIX”線上服務。

### 顏色按鈕

屆時執行相應的功能。

#### 4 ACTION MENU

顯示情境功能清單。

**GUIDE** 

顯示數位節目指南。

**APPS**

訪問各種服務和應用程式。

**BACK**

返回上一個畫面。

**HOME**

顯示電視主選單。

#### 5 +/- (音量)



調節音量。

 (跳轉)



在兩個頻道或兩次輸入之間前後跳轉。電視在當前頻道 / 輸入以及選擇的上一個頻道 / 輸入之間交替切換。

 (靜音)

將聲音消除。再次按下可恢復聲音。

**PROG +/-**  

電視模式：選擇頻道。

文字模式：選擇下一個 () 或上一個 () 頁面。

#### 6 AUDIO

變更目前觀看之節目的語言。



運行電視機和相連的 BRAVIA Sync 相容裝置上操作媒體內容。

 (字幕設定)

開啟或關閉字幕 (此功能可用時)。

**HELP**

顯示說明選單。可以從此處訪問說明指南。

**EXIT**

返回至上一個畫面，或從選單退出。如果交互式應用服務可供使用，按下即可退出服務。

**SYNC MENU**

顯示 BRAVIA 同步選單。

# 連接圖

有關連接的更多資訊，請按遙控器上的 **HELP** 以參閱說明指南。

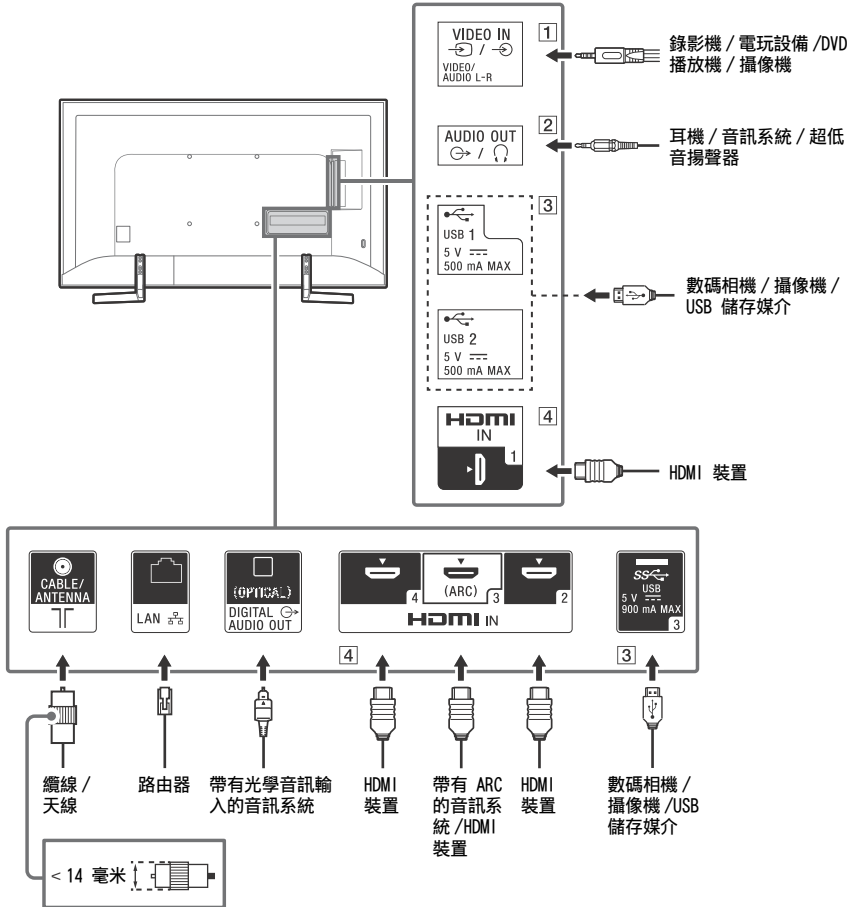

CT

## 1 VIDEO IN

- 如需完成複合連接，請使用模擬延長纜線（非附帶）。

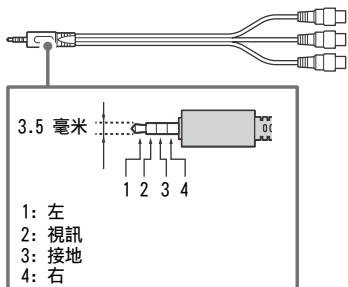

## 2 AUDIO OUT

- 僅支援 3 極立體聲迷你插孔。
- 如需透過相連設備聆聽電視聲音，請按 **HOME**。選擇 [ 設定 ] → [ 聲音設定 ] → [ 耳機 / 聲音輸出 ]，並選擇所需的項目。

## 3 USB 1/2, USB 3

- 連接大型 USB 裝置可能會干擾旁邊連接的其他裝置。
- 連接大型 USB 裝置時，請連接至 USB 1 埠。

## 4 HDMI IN 1/2/3/4

- HDMI 介面可使用單個纜線傳輸數位視訊和音訊。

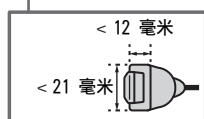

### • HDMI IN 2/3

要享受高品質 4K 50p/60p 內容，將優質速度 HDMI 接線連結至 HDMI IN 2/3，並將 [HDMI 訊號格式] 設定至 [增強格式]。有關支援格式的細節，請參考本手冊（第 16-17 頁）的“規格”。

### • HDMI IN 3 ARC（音頻回傳信道）

將音訊系統連接至 HDMI IN 3 以傳送電視機音訊至音訊系統。支援 HDMI ARC 的音訊系統可將視訊傳送至電視機，並透過同一 HDMI 纜線從電視機接收音訊。如果音訊系統不支援 HDMI ARC，必須額外連接 DIGITAL AUDIO OUT (OPTICAL)。

# 將電視機安裝在牆上

## 使用選購的壁掛式支架

本電視機使用說明書僅提供將電視機安裝到牆上前準備電視機進行壁掛式安裝的步驟。

### 致客戶：

出於產品保護及安全原因，Sony 強烈建議由 Sony 經銷商或授權的承包商安裝電視機。請勿嘗試自行安裝電視機。

### 致 Sony 經銷商和承包商：

安裝、定期維護及檢查本產品時，請充分注意安全。

安裝本產品須具備充足的專業知識，確定牆壁是否能夠承受電視重量時尤為如此。務必委託 Sony 經銷商或授權的承包商將本產品安裝至牆壁上，並在安裝期間充分注意安全。對於因錯誤操作或安裝不當引致的任何損害，Sony 概不負責。

使用壁掛式支架 SU-WL450（非附帶）將電視機安裝到牆上。  
安裝壁掛式支架時，亦請參閱壁掛式支架附帶的使用說明書及安裝指南。

### 註

- 務必將取下的螺絲存放在兒童接觸不到的安全位置。

從電視機背面卸下螺絲。

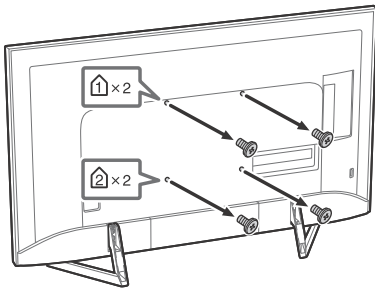

1 確保牆壁有足夠空間以及能支撐至少電視機四倍的重量。請參閱以下列表有關在牆上安裝電視機。有關電視機的重量，請參閱第 16-17 頁（規格）。

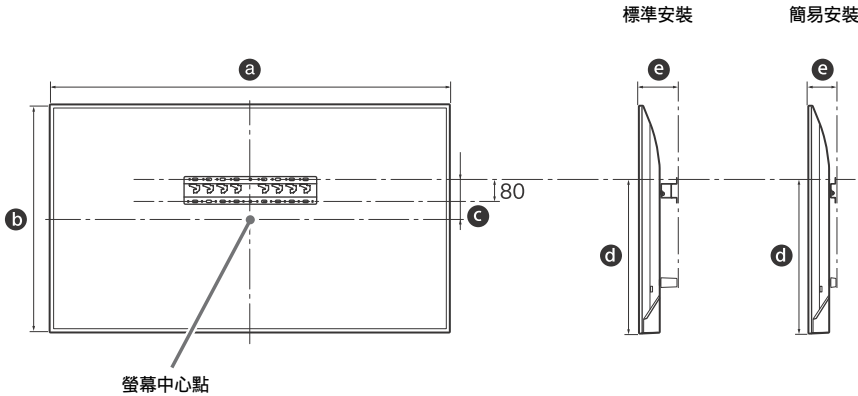

單元：毫米

型號名稱	顯示幕		螢幕中心尺寸		安裝的長度	
	a	b	c	d	e	e
KD-65X9000F	1447	829	211	628	標準安裝 132	簡易安裝 90
KD-55X9000F	1228	706	187	543	132	90
KD-49X9000F	1093	629	163	480	132	90

**註**

- 製表內的數字視安裝而可能略有不同。
- 將電視機安裝至牆壁上後，電視機的上側略微前傾。

2 安裝壁掛式支架的附件組件。參閱壁掛式支架安裝指南之“1”，檢查附件組件。

**註**

- 使用電動螺絲批時，請將扭力設定為約 1.5 N·m {15 kgf·cm}。
- 務必將未使用的組件存放於安全位置，以備日後使用。保管好本說明書，以供日後參考。

**標準安裝**

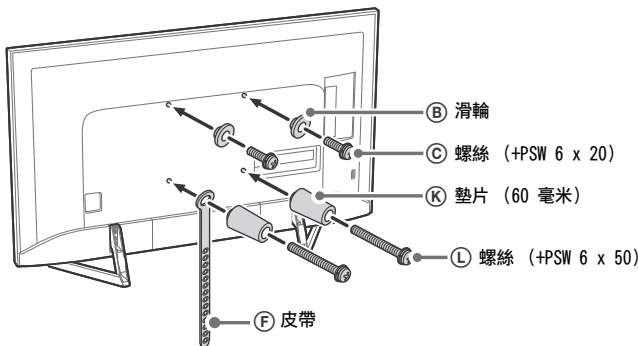

## 簡易安裝

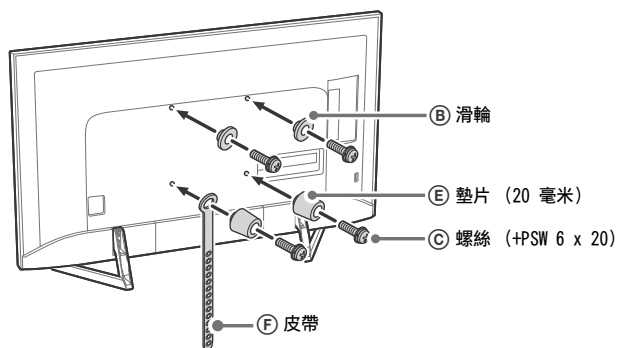

### 3 將必要的連接線連接至電視機。

#### 註

- 將電視機安裝至牆壁後，無法存取任何端子。

### 4 從電視機拆卸桌面底座。

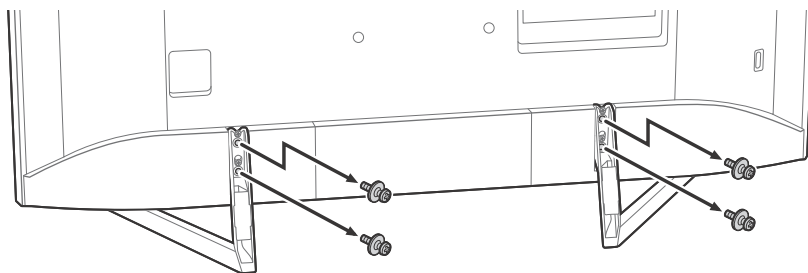

5 將電視機安裝至底座。請參閱壁掛式支架附帶的安裝指南之“5”以及使用說明書之“將電視機安裝在牆上”。

型號名稱	掛鉤位置
KD-65X9000F	b
KD-55X9000F	b
KD-49X9000F	c

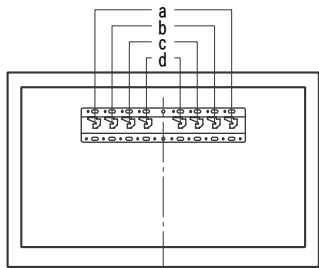

請參閱您所擁有型號之壁掛式支架附帶的說明書，將電視機安裝至牆壁。



## 故障排除

以下問題的一般故障排除：黑螢幕、沒有聲音、凍結畫面、電視機沒有反應或網絡丟失，請依照以下步驟操作。

- 1 按遙控器上的電源按鈕重新啟動電視機，直到顯示一則訊息。電視機將重新啟動。如果電視機未恢復正常，請嘗試拔下電視機的 AC 電源線，等待兩分鐘，然後再將其插入。
- 2 請按遙控器上的 **HELP** 以參閱說明選單。
- 3 將電視機連接至網路，然後執行軟體更新。
- 4 造訪 Sony 支持網站（封底提供的資訊）。

**當顯示 [ 有新的電視系統更新可用 ... ] 訊息時。**  
Sony 強烈建議您選擇 [ 立即更新 ] 更新電視機軟體。這些軟體更新會改善電視機效能或加入新功能。

將顯示以下 [Updating...]（正在更新...）的螢幕，照明 LED 在軟體更新期間閃白燈。

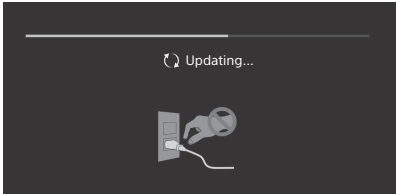

軟體更新期間，請勿拔出 AC 電源線。否則，軟體更新不會徹底完成，並且可能引致軟體故障。軟體更新可能持續長達 15 分鐘。

**在插入電視機時，即使按遙控器或電視機上的電源按鈕，電視機也可能在一段時間不能開啟。**  
系統初始化需要一定時間。等待大約一分鐘，然後再次操作。

## 故障及解決方案

**當照明 LED 閃爍紅燈時。**

- 統計該照明 LED 閃爍的次數（間隔時間為三秒）。  
斷開 AC 電源線兩分鐘重新啟動電視機，然後開啟電視機。  
如果此問題仍然存在，請斷開 AC 電源線，然後聯絡您的經銷商或 Sony 服務中心並告知照明 LED 閃爍的次數。

**沒有畫面（螢幕是黑的）也沒有聲音。**

- 檢查天線 / 訊號線連接。
- 將電視機連接至 AC 電源，然後按電視機或遙控器上的電源按鈕。

**無法調諧某些節目。**

- 檢查天線 / 訊號線連接。

**遙控器無效。**

- 更換電池。

**遙控器上的 EXT.BOX MENU 按鈕不工作。**

- 連接 HDMI CEC 相容裝置並更改至該輸入。

**忘記廣播密碼的家長鎖定。**

- PIN 碼輸入 9999，然後選擇 [ 變更 PIN 號碼 ]。

**電視機周圍溫度升高。**

- 當長時間使用電視機時，電視機周圍溫度會升高。  
用手觸摸這些地方時可能會覺得很燙。

# 規格

## 系統

### 面板系統

LCD (液晶顯示) 面板, LED 背光源

### 電視系統

模擬: I, D/K, B/G, M

數位: DTMB

### 彩色系統

PAL/SECAM/NTSC3.58/NTSC4.43

### 頻道涵蓋範圍

模擬: UHF/VHF/ 纜線

數位: UHF

### 聲音輸出

10 瓦 + 10 瓦

### 無線技術

IEEE802.11ac/a/b/g/n 協議

藍牙版本 4.1

## 輸入 / 輸出插孔

### 天線 / 纜線

VHF/UHF 的 75 歐姆外接端子

### VIDEO IN

視訊 / 音訊輸入 (迷你插孔)

### HDMI IN 1/2/3/4 (支援 4K 解析度、HDCP 2.2 相容)

#### 視訊:

4096 × 2160p (50, 60 Hz)<sup>\*1\*</sup>, 4096 × 2160p (24 Hz)<sup>\*1</sup>, 3840 × 2160p (50, 60 Hz)<sup>\*2</sup>, 3840 × 2160p (24, 25, 30 Hz), 1080p (30, 50, 60 Hz), 1080/24p, 1080i (50, 60 Hz), 720p (30, 50, 60 Hz), 720/24p, 576p, 576i, 480p, 480i, PC 格式<sup>\*3</sup>

\*1 當輸入 4096 × 2160p 且 [寬螢幕模式] 設為 [正常模式] 時, 解析度將顯示為 3840 × 2160p。要顯示 4096 × 2160p, 請將 [寬螢幕模式] 設定設為 [全螢幕模式 1] 或 [全螢幕模式 2]。

\*2 僅限 HDMI IN 2/3。若要支援 18 Gbps, 將 [HDMI 訊號格式] 設定為 [增強格式]。

\*3 有關詳情, 請參閱說明指南。

#### 音訊:

5.1 聲道線性 PCM: 32/44.1/48/88.2/96/176.4/192 kHz 16/20/24 bits, Dolby Digital, Dolby Digital Plus 和 DTS

### ARC (音頻回傳信道) (僅限 HDMI IN 3)

(兩聲道線性 PCM: 48 kHz 16 bits, Dolby Digital, Dolby Digital Plus, DTS)

### DIGITAL AUDIO OUT (OPTICAL)

數位光纖插孔 (兩聲道線性 PCM: 48 kHz 16 bits, Dolby Digital, DTS)

### AUDIO OUT (立體聲迷你插孔)

耳機、音訊輸出、超低音揚聲器

### USB 1, USB 2, SS USB 3

USB 連接埠 1 和 2 支援高速 USB (USB 2.0)

USB 連接埠 3 支援超快速 USB (USB 3.1 Gen 1)

### LAN

10BASE-T/100BASE-TX 接頭 (視網絡的作業環境而定, 連線速度可能不同。不保證本電視的 10BASE-T/100BASE-TX 通訊率和通訊品質。)

## 其他

### 選用的配件

壁掛式支架: SU-WL450

### 作業溫度

0 °C - 40 °C

### 操作濕度

10 % - 80 % 相對濕度 (非冷凝)

## 電源和其他規格

### 電源需求

220 V - 240 V AC, 50 Hz

### 螢幕尺寸 (對角測量) (大約)

KD-65X9000F: 65 英寸 / 163.9 厘米

KD-55X9000F: 55 英寸 / 138.8 厘米

KD-49X9000F: 49 英寸 / 123.2 厘米

### 耗電量

見電視機背面

### 待機耗電量<sup>\*1\*</sup>

0.5 瓦

### 顯示解析度

3840 畫素 (水平) × 2160 條線 (垂直)

### 輸出率

USB 1/2

5 V ---, 500 mA 最大值

USB 3

5 V ---, 900 mA 最大值

## 尺寸 (大約) (寬 × 高 × 深)

### 包含桌面底座

KD-65X9000F: 1447 × 898 × 297 毫米

KD-55X9000F: 1228 × 771 × 268 毫米

KD-49X9000F: 1093 × 694 × 268 毫米

### 不含桌面底座

KD-65X9000F: 1447 × 829 × 69 毫米

KD-55X9000F: 1228 × 706 × 69 毫米

KD-49X9000F: 1093 × 629 × 69 毫米

## 質量 (大約)

### 包含桌面底座

KD-65X9000F: 25.5 千克

KD-55X9000F: 19.1 千克

KD-49X9000F: 14.5 千克

### 不含桌面底座

KD-65X9000F: 24.5 千克

KD-55X9000F: 18.2 千克

KD-49X9000F: 13.6 千克

\*1 電視完成必要的內部處理程序之後會達到指定的待機電力。

\*2 在電視機連接網路時，待機耗電量會增加。

#### 註

- 選購配件的供應視國家 / 區域 / 電視機型號 / 存貨而定。
- 設計與規格可能變更而不事先通知。

#### 商標資訊

- HDMI、HDMI 高畫質多媒體介面及 HDMI 標誌為 HDMI Licensing Administrator, Inc. 在美國及其他國家的商標或註冊商標。
- 本產品經過杜比實驗室的授權而製造。Dolby、杜比、Dolby Audio、和雙 D 記號是杜比實驗室的商標。
- “BRAVIA”、BRAVIA 和 BRAVIA Sync 是 Sony Corporation 的商標或註冊商標。
- Gracenote、Gracenote 標誌和標誌字型以及 “Powered by Gracenote” 標誌是 Gracenote, Inc. 在美國和 / 或其他國家的註冊商標或商標。
- Vewd® Core. Copyright 1995–2017 Vewd Software AS. All rights reserved.
- Google、Android TV、Google Play、Chromecast built-in、YouTube 和其他相關標記和標誌均為 Google LLC 的商標。
- Wi-Fi®、Wi-Fi Alliance®、Wi-Fi Direct® 和 Miracast® 是 Wi-Fi Alliance 的註冊商標。
- Wi-Fi Protected Setup™ 是 Wi-Fi Alliance 的商標。
- Wi-Fi CERTIFIED™ 標誌是 Wi-Fi Alliance 的認證標誌。
- 有關 DTS 專利，請參閱 <http://patents.dts.com>。由 DTS, Inc. 授權製造。DTS、其標誌、& DTS 連同其標誌是註冊商標，而 DTS Digital Surround 是 DTS, Inc. 的商標。© DTS, Inc. 版權所有。
- 藍牙® 文字標記和徽標是 Bluetooth SIG, Inc. 持有的註冊商標，任何使用此商標的 Sony Corporation 均需獲得授權。其他商標和商標名稱為各自所有者的商標和商名。
- Netflix 是 Netflix, Inc. 的註冊商標。
- © 2017 RealNetworks, Inc. 版權所有。專利申請中。RealMedia, RealNetworks 以及它們的標誌是 RealNetworks, Inc. 的商標或註冊商標。
- TUXERA 是 Tuxera Inc. 在美國及其他國家 / 地區的註冊商標。
- USB-IF SuperSpeed USB Trident 標誌是 USB Implementers Forum, Inc. 的註冊商標。
-  所有其他商標屬於其各自的所有者。

**HDMI™**  
HIGH-DEFINITION MULTIMEDIA INTERFACE



**4K**

實際解析度：  
3840 x 2160 畫素



Help Guide  
說明指南

[http://rd1.sony.net/help/tv/fga1/h\\_ga/](http://rd1.sony.net/help/tv/fga1/h_ga/)



Customer Support and Contact:  
用戶支援和聯絡:

<http://www.sony-asia.com/support>

<http://www.sony.net/>

© 2018 Sony Visual Products Inc. Printed in Japan